

RC4-N30 Carpet Stair Nosing

The **RC4-N30** Non-Slip Anodized Stair Nosings provide step edge colour contrast, long-lasting anti-slip protection and beautiful appearance. The RC4-N30 provide an affordable way to renovate and modernize carpeted stairways and improve stairway safety.

Engineered for Durability

- The hard-wearing silicon carbide non-slip material is integrally bonded to the aluminum substrate. Thousands of people can walk on it with no signs of wear and tear.
- The thick anodized finish is aesthetically pleasing, prevents corrosion, and is extremely hard and abrasion resistant. The anodized aluminum surface is harder than pure aluminum, second only to diamonds hard crystalline structure.

Step Edge Safety

- The colour contrasting the non-slip material provides excellent step edge visibility.

Environmentally Friendly

- LEED points qualified
- Recyclable; No disposable cost

For Indoor Use and Outdoor Use

- Tested to accelerated UV/Weathering Exposure, Salt Spray Resistance, Freeze Thaw Resistance and Washability. Ecoglo[®] products easily passed with excellent results.

General Information

- Install with polyurethane adhesive and mechanical fasteners, or adhesive only.
- Supplied with pre-drilled countersunk holes. Includes stainless steel fasteners and concrete nylon anchors. Standard location is 2" from each end and approx. 12" apart.
- Available in cut to length sizes. (Tolerance +or- 1/8") Standard lengths are 8ft and 10ft.
- Inserts are supplied unattached. Inserts are installed over the mechanical fasteners using a polyurethane adhesive (included). Inserts can be cut using a shear. Aluminum nosings are cut with a saw. Cutting inserts with saw will damage the saw blade. Inserts are installed with a premium polyurethane adhesive.
- Weight: 0.896 lbs/ft.

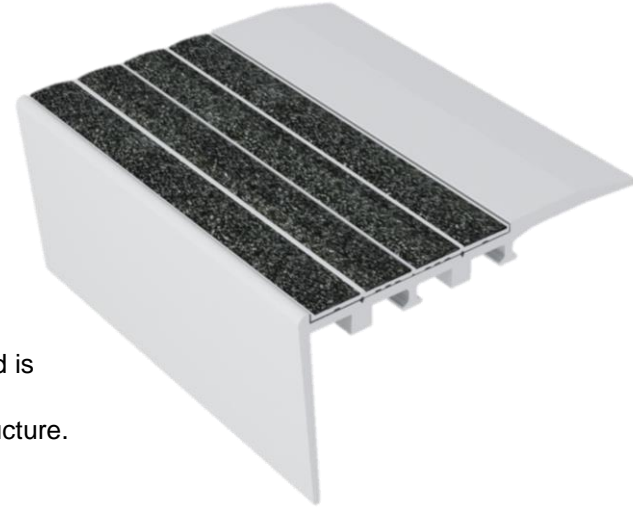

Product Colours

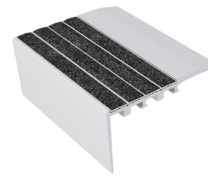

Black

RC4170



Grey

RC4160

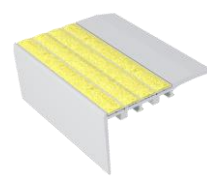

Yellow

RC4150

Product Dimensions

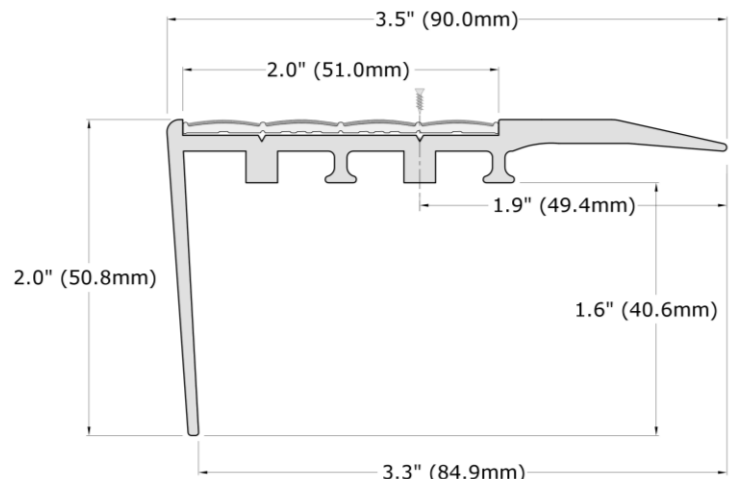

RC4-N30 Carpet Stair Nosing

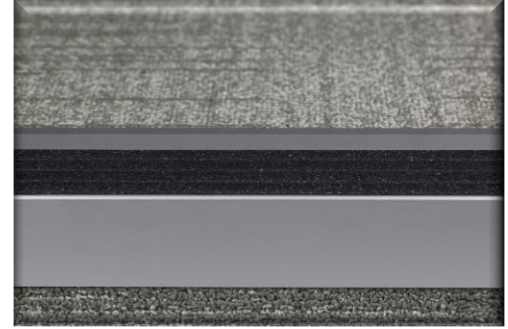
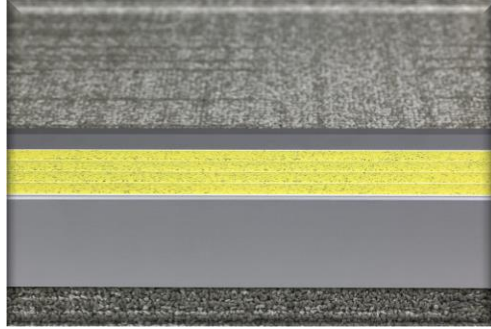
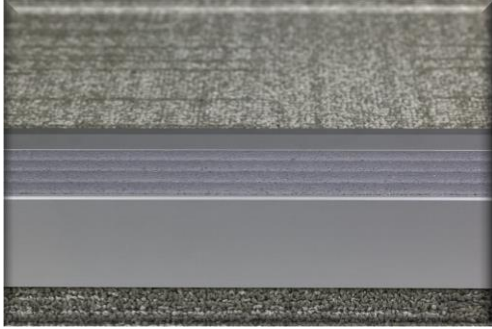

Qualifies for LEED Points

MR Credit 2: Construction Waste Management Divert from Land Fill

- Products are Aluminum based and 100% recyclable.

MR Credit 4: Recycled Content

- Products are Aluminum based and approximately 20% of the aluminum content in an Ecoglo secondary billet specification is recycled scrap.

Ecoglo's Recommended Installation Adhesive has low VOC's and qualifies for Indoor Environmental Quality credits for low emitting materials: EQc4.1

Aluminum Finish

- Available in Clear Anodized Aluminum Finish.
- Black, Light Bronze and Dark Bronze Anodize finishes are available at additional cost.

Benefits and Technical Details: Ecoglo RC4-N30 meets or exceeds the performance criteria specified in the following tests or standards:

UV Stability

High durability indoors and outdoors.

- ASTM G155-04 Cycle 1 2000hrs, Standard Practice for Operating Xenon Arc Light Apparatus for Exposure of Nonmetallic Materials.
- Salt Spray Resistance: ASTM B117-97 500hrs, Standard Practice for Operating Salt Spray (Fog) Apparatus.
- Freeze-Thaw Resistance: ASTM C1026-87(1996), Standard Test Method for Measuring the Resistance of Ceramic Tile to Freeze-Thaw Cycling

Slip Resistant

Reduces slips.

- UL410, Standard for Slip Resistance for Floor Surface Materials.
- AS/NZS 4586-1999, Slip Resistance Classification of New Pedestrian Surface Materials.

Abrasion Resistance

Hard wearing.

- ASTM D1242-95a, Standard Test Methods for Resistance of Plastic Materials to Abrasion.
- ASTM B 244-97, Test Methods for Measurement of Anodic Coatings on Aluminum and other Nonconductive Coatings on Nonmagnetic Basis Metals with Eddy-Current Instruments.
- ASTM B137-95(2000), Test Method for Measurement of Coating Mass per Unit Area of Anodically Coated Aluminum.
- ASTM F510-93(2004), Standard Test Method for Resistance to Abrasion of Resilient Floor Coverings Using an Abrader with a Grit Feed Method.
- JIS H8682-1:1999, Test methods for abrasion resistance of anodic oxide coatings on aluminum and aluminum alloys- Wheel wear test.

Washability

Easy Cleaning.

- ASTM D4828-94(2003), Standard Test Methods for Practical Washability of Organic Coatings.
- ASTM B136-84(1998), Standard Test Method for Measurement of Stain Resistance of Anodic Coatings on Aluminum.

Flammability

Does not burn.

- ASTM E162-02, Standard Test Method for Surface Flammability of Materials Using a Radiant Heat Energy Source.
- ASTM D635-03, Standard Test Method for Rate of Burning and/or Extent and Time of Burning of Plastics in a Horizontal Position.
- FAA AC 23.2 Paragraph 4.b, Horizontal Burn Test.

Contact Ecoglo Inc. for a quick quote or to obtain more information about our emergency lighting products.

Made in USA

KINESIK Engineered Products Incorporated

2213 North Sheridan Way
Mississauga, Ontario L5K 1A3
Canada

Phone: 855.364.7763
Fax: 800.769.4463
www.kinesik.ca